

SPEHO

ILLUMINATED MIRRORS

Specialists in the design and manufacture of
bespoke illuminated mirrors for projects.

*Especialistas en diseño y fabricación de espejos
iluminados a medida para proyectos.*



Catalogue
Catálogo



Corporate / Empresa

Design a custom mirror / Diseña tu espejo a medida

Direct lighting Collection / Colección Iluminación Directa

Alba



Edna



Katie

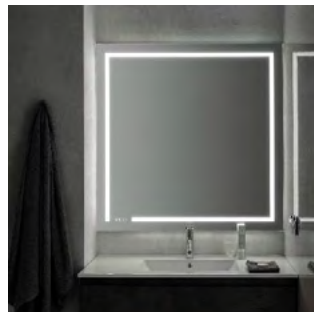

Lisbeth

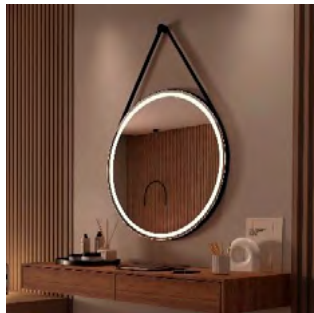

Sandra

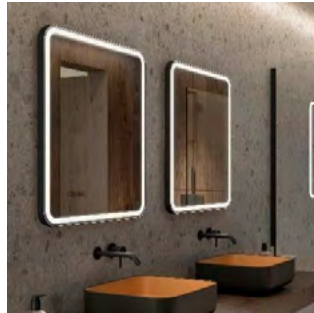

Ambient lighting Collection / Colección Iluminación Ambiente

Dana

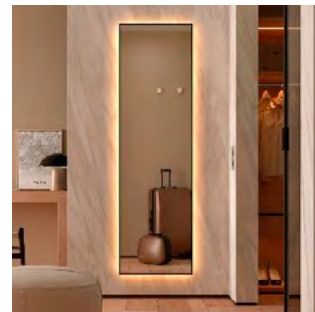

Goya

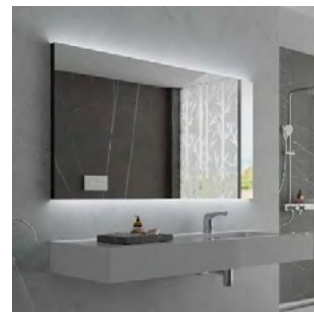

Grayce

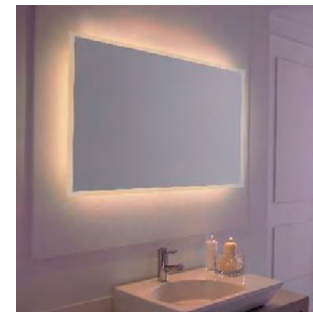

Livia

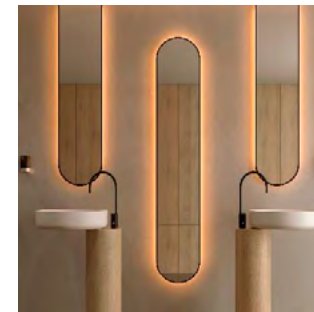

Mara



Sienna

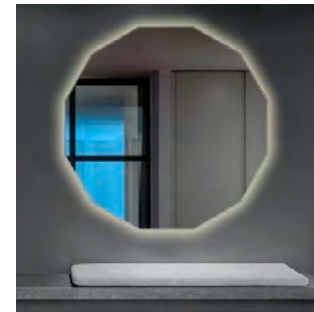

Thiara

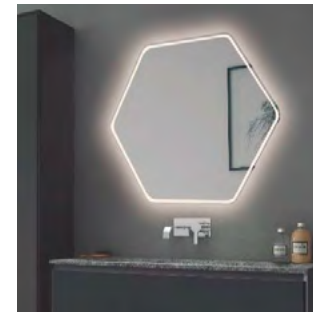

Click install system / Sistema Click install

SPEHO

ILLUMINATED MIRRORS

The illuminated mirror is a product with a highly positive impact on spaces which, in addition to offering light, gives the space a touch of distinction and the sensation of wider and deeper spaces, while improving user experience.

El espejo iluminado es un producto con un impacto altamente positivo en los espacios que, además de ofrecer luminosidad, aporta al ambiente un toque de distinción y la sensación de espacios más amplios y profundos, a la vez que mejora la experiencia del usuario.





Speho is a brand of EBIR, a company with a history of more than 25 years of experience manufacturing bathroom lighting, being leaders in the European market. We are a supplier of the main hotel chains.

We also offer the advantage that, as a manufacturer, we can design and develop customized and personalized products, adapting to the specific needs of the concept of the space.

The product we manufacture is very specialized, and hence our degree of knowledge of it.

Speho es una marca de EBIR, una empresa con una trayectoria de más de 25 años de experiencia fabricando iluminación para baño, siendo líderes en el mercado Europeo. Somos proveedor de las principales cadenas hoteleras.

Ofrecemos además la ventaja de que, al ser fabricante, podemos diseñar y desarrollar producto a medida y personalizado, adaptándonos a las necesidades específicas del concepto del espacio.

El producto que fabricamos es muy especializado, y de ahí nuestro grado de conocimiento del mismo.

Made in
Spain

Waranty and trust

All our mirrors are certified according to the highest quality and safety standards. We are so confident in the quality of our mirrors that they all come with a 5-year warranty. In addition, we offer our clients a professional Technical Assistance service.

Garantía y confianza

Todos nuestros espejos están certificados de acuerdo a los estándares más exigentes de calidad y seguridad. Confiamos tanto en la calidad de nuestros espejos que todos cuentan con una garantía de 5 años. Además, ponemos a disposición de nuestros clientes un servicio profesional de Asistencia Técnica.

Facilities, innovation and team

Our manufacturing, storage and distribution facilities are located in Valencia, Spain and Zhongshan, China .

The company has, at an international level, more than 250 employees highly specialized in lighting. 2 Factories and +30.000 m² facilities where an important space is dedicated to the innovation and design of new proposals, testing laboratories with real users and the different product quality tests.

Instalaciones, innovación y equipo

Nuestras instalaciones de fabricación, almacenamiento y distribución están ubicadas en Valencia, España y Zhongshan, China.

La empresa cuenta, a nivel internacional, con más de 250 empleados altamente especializados en iluminación.

2 fábricas y +30.000 m² de instalaciones donde se dedica un importante espacio a la innovación y diseño de nuevas propuestas, laboratorios de testeo con usuarios reales y a las distintas pruebas de calidad de producto.

Commitment to Sustainability

Firmly committed to sustainability, in all our mirrors we take advantage of the energy savings that LED technology entails, with the aim of making it more efficient every day; and we are constantly working to incorporate more recyclable and replaceable components into our products, and to deliver them to our customers in more sustainable packaging.

Sostenibilidad

Comprometidos firmemente con la sostenibilidad, apostamos en todos nuestros espejos por el ahorro energético que supone la tecnología LED, con el objetivo de que sea más eficiente cada día; y trabajamos, de manera constante para incorporar cada vez más componentes reciclables y reemplazables en nuestros productos, y hacerlos llegar a nuestros clientes en embalajes más sostenibles.



1 LIGHTING
ILUMINACIÓN



Direct
Directa

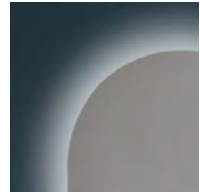

Ambient
Ambiente

2 DECORATIVE FRAME
MARCO DECORATIVO

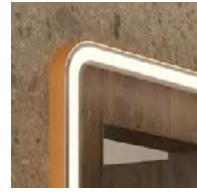

Metal
Metálico

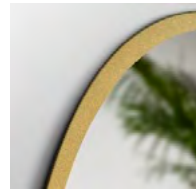

Screen printed
Serigrafiado

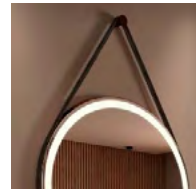

Leather
Piel



Finishings
Acabados

* Check other finishings.
* Consultar otros acabados.

3 SHAPES
FORMAS



Square/
Rectangle
Cuadrado/
Rectangular

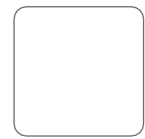

Rounded
Square/
Rectangle
Cuadrado/
Rectangular
redondeado

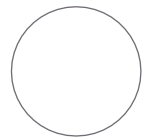

Circle
Círculo

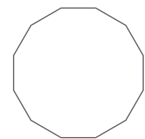

Customizable
polygons
Polígonos
personalizables

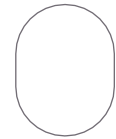

Capsule
Cápsula



Customizable
organic
Orgánico
personalizable

4 LIGHT DESIGN
DISEÑO DE LA LUZ

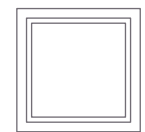

Perimeter
Perimetral

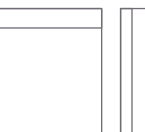
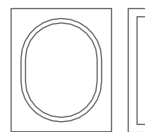
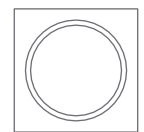
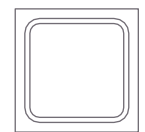

Window
Ventana

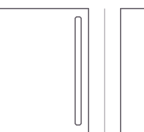
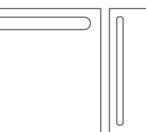

Without
sandblasting
Sin arenado

5 COLOR TEMPERATURE
TEMPERATURA DE COLOR



3000K



4000K



5700K

6 LED STRIP TYPE
TIPO DE TIRA DE LED



Led strip.
Tira led
120 leds/m

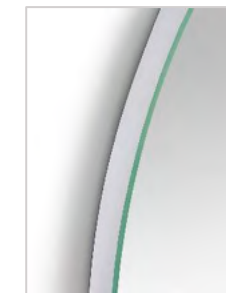

Glow Plus led strip.
Tira led Glow Plus
180 leds/m

7 SIZE
TAMAÑO



Please consult us for special sizes.
Consultar para medidas especiales.

8 EXTRAS
EXTRAS



Glow Plus led strip.
Tira led Glow Plus



Defogger.
Antivaho.



Integrated magnifying mirror.
Espejo aumento integrado.



Lighted magnifying mirror.
Espejo aumento iluminado.



Touch sensor.
Sensor táctil



Laser or backlit logo.
Logo láser o retroiluminado.



Adjustable intensity.
Intensidad regulable.



Adjustable color temperature
Temperatura de color regulable



Anticorrosive protection.
Protección anticorrosión.



2 Positions.
2 Posiciones.

Direct lighting Collection
Colección Luz Directa

ALBA collection

Direct lighting



Square and rectangular mirrors with two vertical or horizontal sandblasted windows. With an elegant aluminum profile on both sides.

Ideal for bathrooms due to the functionality provided by the light: perfect for precision tasks.

Espejos cuadrados y rectangulares de iluminación directa a través de dos ventanas laterales verticales u horizontales. Con perfil de aluminio a los laterales.

Ideal para baños gracias a la funcionalidad de la luz que proporciona, perfecta para el desempeño de tareas de precisión.



SPEHO

ILLUMINATED MIRRORS

ALBA collection

Direct lighting

SPEHO
ILLUMINATED MIRRORS



Specifications

Especificaciones

Click install System
Sistema Qlick install

Lighting System AC-LED Bar
Sistema de iluminación regleta AC-LED

Power 220-240V
Potencia 220-240V

Color temperature 3000K
Temperatura de color 3000K

Distance of the sandblasting to the edge 45mm
Distancia del arenado al borde 45mm

Standard sandblasting width 30mm
Ancho estándar del arenado 30mm

Decorative aluminum frame
Marco decorativo de aluminio

Glass 4 mm
Luna de 4 mm

| 4000K | 5700K
| 4000K | 5700K

(Min 45mm)
(Min 45mm)

(Optional 10 - 35 mm)
(Opcional 10 - 35 mm)

Extra

Extras



Defogger.
Antivaho.



Touch sensor.
Sensor táctil.



Integrated magnifying mirror.
Espejo aumento integrado.
(For sizes / Para dimensiones > 800 mm)



Laser or backlit logo.
Logo láser o retroriluminado.



Lighted magnifying mirror.
Espejo aumento iluminado.
(For sizes / Para dimensiones > 800 mm)

Standard sizes (mm)

Dimensiones estándares (mm)

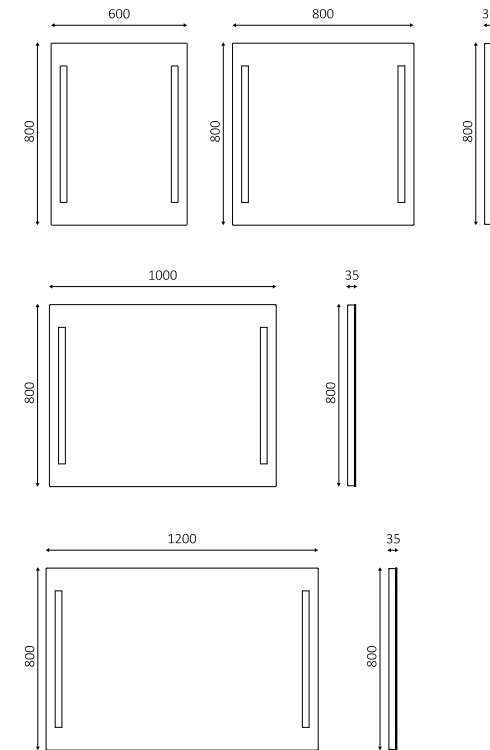

Please consult us for special sizes.
Consultar para medidas especiales.

Acabados

Finishing options



*Other decorations
available on demand

*Otros acabados
disponibles



EDNA collection

Direct lighting



Square and rectangular mirrors with a perimetral sandblasting, and a decorative aluminium frame.

Ideal for bathrooms due to the functionality provided by the light; perfect for precision tasks.

Espejos cuadrados y rectangulares de iluminación directa a través de un arenado perimetral, con marco decorativo de aluminio.

Ideal para baños gracias a la funcionalidad de la luz que proporciona, perfecta para el desempeño de tareas de precisión.

SPEHO
ILLUMINATED MIRRORS



EDNA collection

Direct lighting

SPEHO
ILLUMINATED MIRRORS



Specifications

Especificaciones

Click install System
Sistema Click install

Lighting System PVC frame + led strip 120leds/m
Sistema de iluminación marco PVC + tira de led 120leds/m

Power 220-240V
Potencia 220-240V

(Optional 110V)
(Opcional 110V)

Color temperature 3000K
Temperatura de color 3000K

| 4000K | 5700K
| 4000K | 5700K

Distance of the sandblasting to the edge 15mm
Distancia del arenado al borde 15mm

(Min 15mm)
(Min 15mm)

Standard sandblasting width 15mm
Ancho estándar del arenado 15mm

(Optional 10 - 18 mm)
(Opcional 10 - 18 mm)

PVC frame
Marco decorativo de PVC

Glass 4 mm
Luna de 4 mm

Extra

Extras

- Defogger.
Antivaho.
- Touch sensor.
Sensor táctil.
- Adjustable color temperature
Temperatura de color regulable
- Integrated magnifying mirror.
Espejo aumento integrado.
(For sizes / Para dimensiones > 800 mm)
- Laser or backlit logo.
Logo láser o retroiluminado.
- Adjustable intensity.
Intensidad regulable.
- Lighted magnifying mirror.
Espejo aumento iluminado.
(For sizes / Para dimensiones > 800 mm)
- 2 Positions
2 Posiciones

Standard sizes (mm)

Dimensiones estándares (mm)

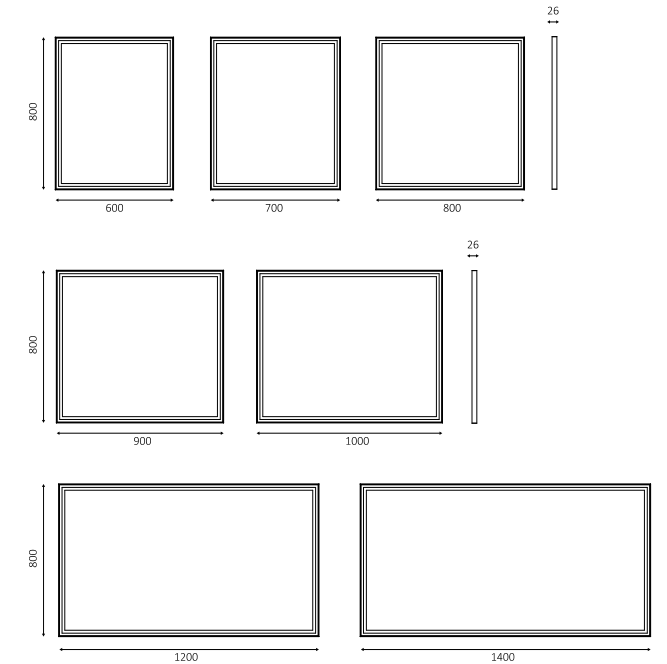

Please consult us for special sizes.
Consultar para medidas especiales.

Acabados

Finishing options

- Grey
Gris
- Matt black*
Negro mate*

*Available on demand,
MOQ 200 units.
*Disponible bajo pedido
mínimo 200 uds.



KATIE collection

Direct lighting



Square or rectangular mirrors with a perimetral sandblasting. With smoothly polished edges and without frame, to create a "free floating" effect on the wall.

Ideal for bathrooms due to the functionality provided by the light: perfect for precision tasks.

Espejos cuadrados o rectangulares de iluminación directa a través de un arenado perimetral. Con cantos suavemente pulidos y sin marco, para crear un "efecto volado" sobre la pared.

Ideal para baños gracias a la funcionalidad de la luz que proporciona, perfecta para el desempeño de tareas de precisión.



SPEHO

ILLUMINATED MIRRORS

KATIE collection

Direct lighting

SPEHO
ILLUMINATED MIRRORS



Specifications

Especificaciones

Click install System
Sistema Qlick install

Lighting System Liner + led trip 120 led/m
Sistema de iluminación Liner + tira LED 120 led/m

Power 220-240V (Optional 110V)
Potencia 220-240V (Opcional 110V)

Color temperature 3000K | 4000K | 5700K
Temperatura de color 3000K | 4000K | 5700K

Distance of the sandblasting to the edge 18mm (Min 15mm).
Distancia del arenado al borde 18mm (Min 15mm)

Standard sandblasting width 15mm (Optional 10 - 30 mm)
Ancho estándar del arenado 15mm (Opcional 10 - 30 mm)

Glass 4 mm
Luna de 4 mm

Extra

Extras

- Defogger. Antivaho.
- Touch sensor. Sensor táctil.
- Adjustable color temperature. Temperatura de color regulable.
- Integrated magnifying mirror. Espejo aumento integrado. (For sizes / Para dimensiones > 800 mm)
- Laser or backlit logo. Logo láser o retroiluminado.
- Adjustable intensity. Intensidad regulable.
- Lighted magnifying mirror. Espejo aumento iluminado. (For sizes / Para dimensiones > 800 mm)
- 2 Positions. 2 Posiciones.

Standard sizes (mm) Dimensiones estándares (mm)

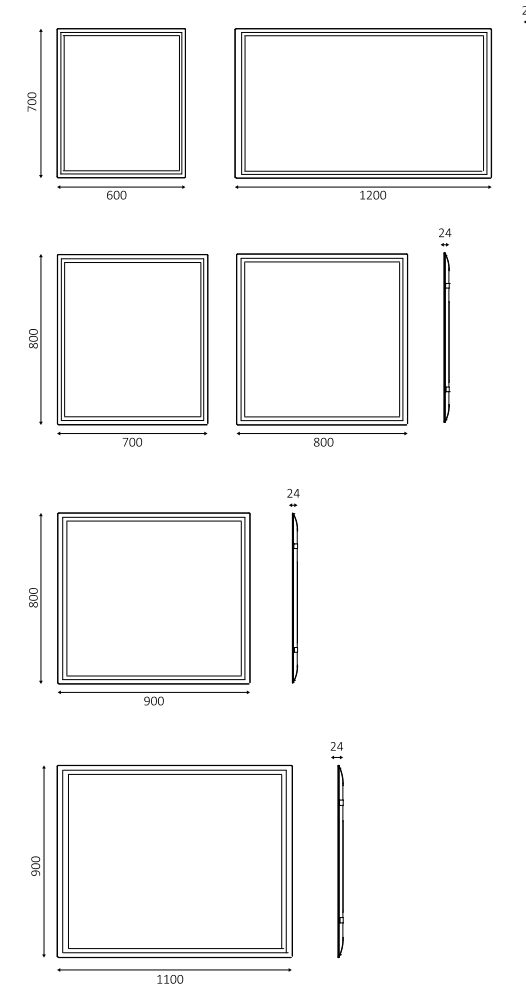

Please consult us for special sizes.
Consultar para medidas especiales.

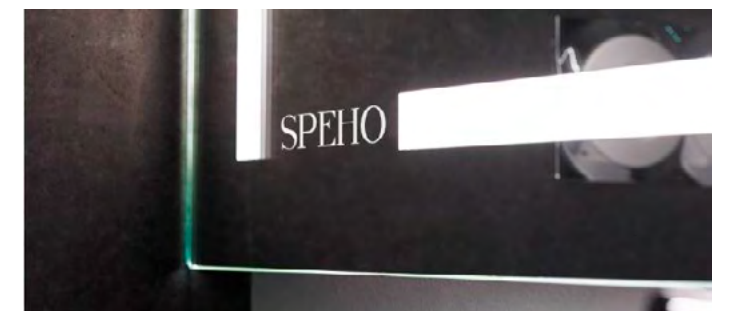

LISBETH collection

Direct lighting



Round mirrors with a decorative faux-leather strap to simulate a suspension effect. Direct lighting through perimetral sandblasting.

Its design lends fluidity and distinction to the room through imitation-leather decoration and fastening with a personalized finish.

Espejos redondos con correa en simil-piel decorativa para simular un efecto de suspensión. Iluminación directa a través de un arenado perimetral.

Diseño que proporciona fluidez y distinción a la estancia, gracias a la decoración en simil-piel y el bolón en acabados personalizables.



SPEHO
ILLUMINATED MIRRORS

LISBETH collection

Direct lighting

SPEHO
ILLUMINATED MIRRORS



Specifications

Especificaciones

Lighting System thermoformed base + tira de led 120leds/m
Sistema de iluminación base termoconformada + tira de led 120leds/m

| | |
|--|--|
| Power 220-240V Potencia 220-240V | (Optional 110V) (Opcional 110V) |
| Color temperature 3000K Temperatura de color 3000K | 4000K 5700K 4000K 5700K |
| Distance of the sandblasting to the edge 15mm Distancia del arenado al borde 15mm | (Min 10mm) (Min 10mm) |
| Standard sandblasting width 18mm Ancho estándar del arenado 18mm | (Optional 12/15 mm) (Opcional 12/15 mm) |
| Glass 4 mm Luna de 4 mm | |

Mirror with thermoformed frame covered by a synthetic leather strap
Espejo con marco termoconformado cubierto por una correa de piel sintética

Extra

Extras

- Defogger.
Antivaho.
- Touch sensor.
Sensor táctil.
- Adjustable color temperature
Temperatura de color regulable
- Integrated magnifying mirror.
Espejo aumento integrado.
(For sizes / Para dimensiones > 800 mm)
- Laser or backlit logo.
Logo láser o retroiluminado.
- Lighted magnifying mirror.
Espejo aumento iluminado.
(For sizes / Para dimensiones > 800 mm)
- Adjustable intensity.
Intensidad regulable.

Standard sizes (mm) Dimensiones estándares (mm)

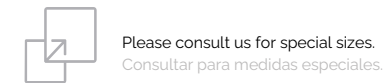
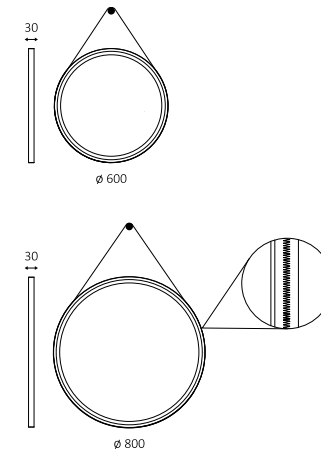

Acabados

Finishing options

Strap / Correa

Matt black
Negro mate

*Other decorations
available on demand

*Otros acabados
disponibles



SANDRA collection

Direct lighting



Mirrors with rounded corners and metal frame with perimeteral sandblasting, the best way to see your face without any kind of shadow.

Ideal for bathrooms, beauty corners and dressing rooms: spaces for creating a distinctive ambience in which precision tasks can also be performed.

Espejos con esquinas redondeadas y marco metálico con arenado perimetral, la mejor para verse el rostro sin ningún tipo de sombra.

Ideal para baños, beauty corners y vestidores: Espacios donde poder crear un ambiente con personalidad en el que además se pueda llevar a cabo tareas de precisión.



SPEHO

ILLUMINATED MIRRORS

SANDRA collection

Direct lighting

SPEHO
ILLUMINATED MIRRORS



Specifications

Especificaciones

Click install System
Sistema Qlick install

Lighting System metal frame + led strip 120leds/m
Sistema de iluminación marco metálico + tira de led 120leds/m

| | |
|--|--|
| Power 220-240V Potencia 220-240V | (Optional 110V) (Opcional 110V) |
| Color temperature 3000K Temperatura de color 3000K | 4000K 5700K 4000K 5700K |
| Distance of the sandblasting to the edge 15mm Distancia del arenado al borde 15mm | (Min 15mm) (Min 15mm) |
| Standard sandblasting width 15mm Ancho estándar del arenado 15mm | (Optional 12/18 mm) (Opcional 12/18 mm) |

Decorative frame: aluminum
Marco decorativo: aluminio

Glass 4 mm
Luna de 4 mm

Extra

Extras



Standard sizes (mm)

Dimensiones estándares (mm)

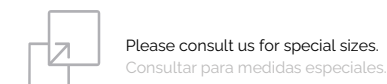
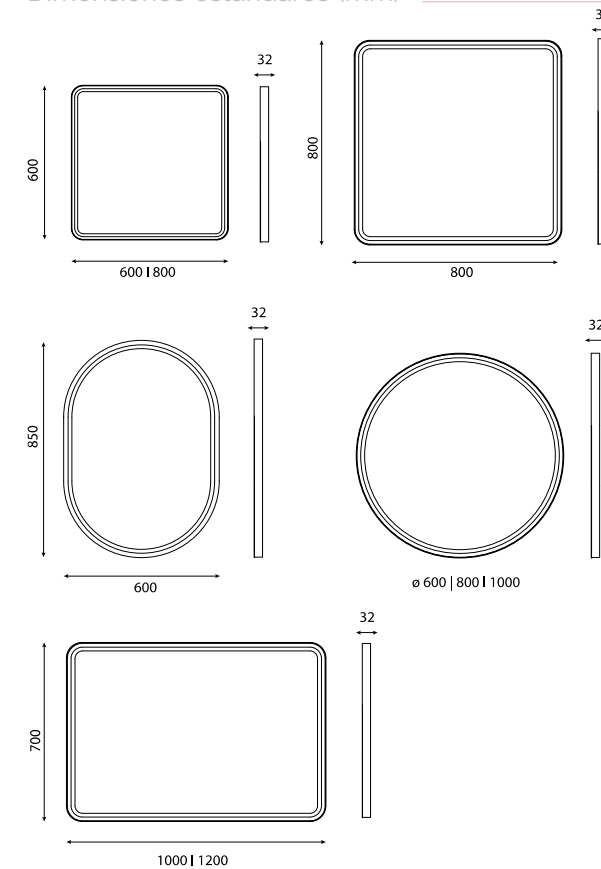

Acabados

Finishing options



Ambient lighting Collection
Colección Iluminación Ambiente

DANA collection

Ambient lighting



Square and rectangular mirrors with an extruded aluminum frame and integrated LED. Ideal for bathrooms, halls, hallways... Spaces where you can create an environment with personality.

Espejos cuadrados y rectangulares con marco de extrusión de aluminio con LED integrado para ofrecer una iluminación indirecta. Ideal para baños, recibidores, zonas de paso... Espacios donde poder crear un ambiente con personalidad.



SPEHO
ILLUMINATED MIRRORS

DANA collection

Ambient lighting

SPEHO
ILLUMINATED MIRRORS



Specifications

Especificaciones

Click install System
Sistema Qlick install

Lighting System led strip 120leds/m
Sistema de iluminación tira de led 120leds/m

Power 220-240V (Optional 110V)
Potencia 220-240V (Opcional 110V)

Color temperature 3000K | 4000K | 5700K
Temperatura de color 3000K | 4000K | 5700K

Decorative frame: aluminum
Marco decorativo de aluminio

Glass 4 mm
Luna de 4 mm

Extra

Extras



Standard sizes (mm)

Dimensiones estándares (mm)

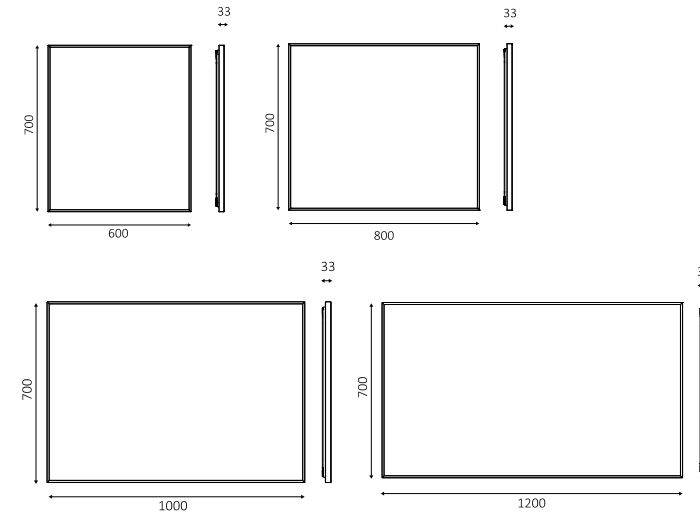

Please consult us for special sizes.
Consultar para medidas especiales.

Acabados

Finishing options

Matt black
Negro mate

*Other decorations
available on demand

*Otros acabados
disponibles



GOYA collection

Ambient lighting



SPEHO

ILLUMINATED MIRRORS



Mirrors with a decorative side profiles to project the light from the top and bottom of the mirror.

With and without magnifying mirror.

Espejos con perfil lateral decorativo que ofrece iluminación indirecta mediante proyección de la luz por la parte superior e inferior del espejo.

Con y sin espejo de aumento.

GOYA collection

Ambient lighting

SPEHO
ILLUMINATED MIRRORS



Specifications

Especificaciones

Click install System
Sistema Qlick install

Lighting System led strip 120leds/m
Sistema de iluminación tira de led 120leds/m

Power 220-240V (Optional 110V)
Potencia 220-240V (Opcional 110V)

Color temperature 3000K | 4000K | 5700K
Temperatura de color 3000K | 4000K | 5700K

Decorative frame aluminum
Marco decorativo de aluminio

Glass 4 mm
Luna 4 mm

Sandblasted magnifying mirror width: 19 mm
Ancho del arenado del espejo de aumento: 19 mm

Extra

Extras



Standard sizes (mm)
Dimensiones estándares (mm)

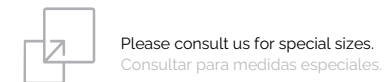
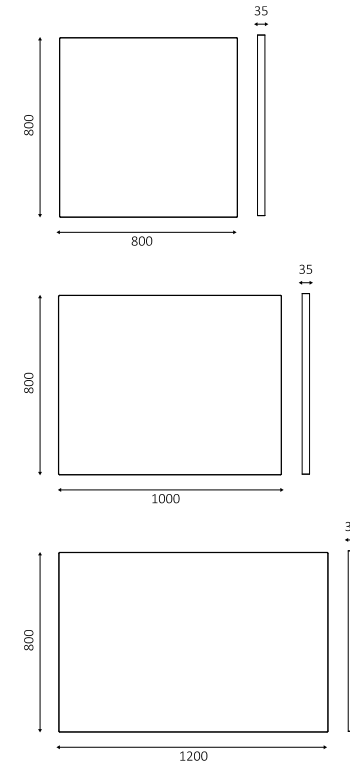

Acabados
Finishing options

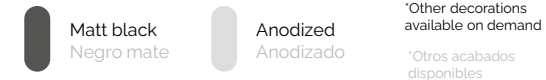

*Other decorations available on demand
*Otros acabados disponibles

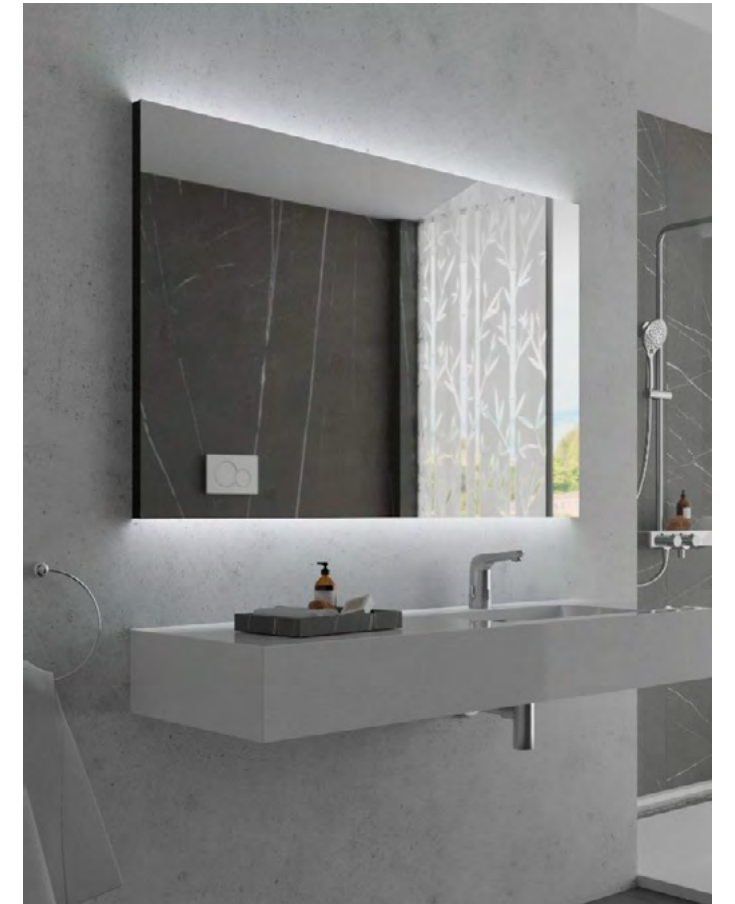

GRAYCE collection

Ambient lighting



Perimetral frameless sandblasted mirrors, with smoothly polished edges to create a "free- floating effect" on the wall.

It is an ideal mirror for areas where calm predominates, providing very pleasant indirect lighting and perfect and harmonious integration with the rest of the space.

Espejos de luz indirecta con arenado. perimetral a testa sin marco, con cantos suavemente pulidos para crear un "efecto volado" sobre la pared.

Es un espejo ideal para zonas donde predomina la calma, proporcionando una iluminación indirecta muy agradable y una integración perfecta y armoniosa con el resto del espacio.



SPEHO
ILLUMINATED MIRRORS

GRAYCE collection

Ambient lighting

SPEHO
ILLUMINATED MIRRORS



Specifications Especificaciones

Qlick install System
Sistema Qlick install

Lighting System led strip 120leds/m
Sistema de iluminación tira de led 120leds/m

Power 220-240V
Potencia 220-240V

(Optional 110V)
(Opcional 110V)

Color temperature 3000K
Temperatura de color 3000K

| 4000K | 5700K
| 4000K | 5700K

Standard sandblasting width 20mm
Ancho estándar del arenado 20mm

(Optional 10 - 40 mm)
(Opcional 10 - 40 mm)

Glass 4 mm
Luna de 4 mm

Extra Extras

- Defogger.
Antivaho.
- Lighted magnifying mirror.
Espejo aumento iluminado.
(For sizes / Para dimensiones > 800 mm)
- Adjustable intensity.
Intensidad regulable.
- Integrated magnifying mirror.
Espejo aumento integrado.
(For sizes / Para dimensiones > 800 mm)
- Touch sensor.
Sensor táctil.
- Adjustable color temperature
Temperatura de color regulable
- Laser or backlit logo.
Logo láser o retroiluminado.
- 2 Positions
2 Posiciones

Standard sizes (mm) Dimensiones estándares (mm)

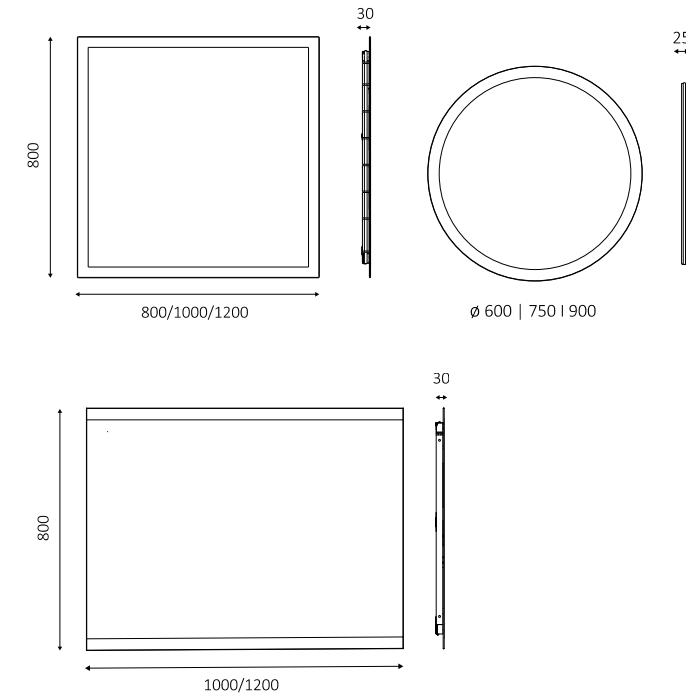

Please consult us for special sizes.
Consultar para medidas especiales.

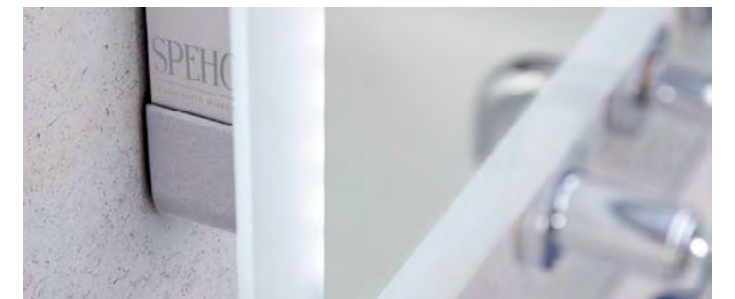
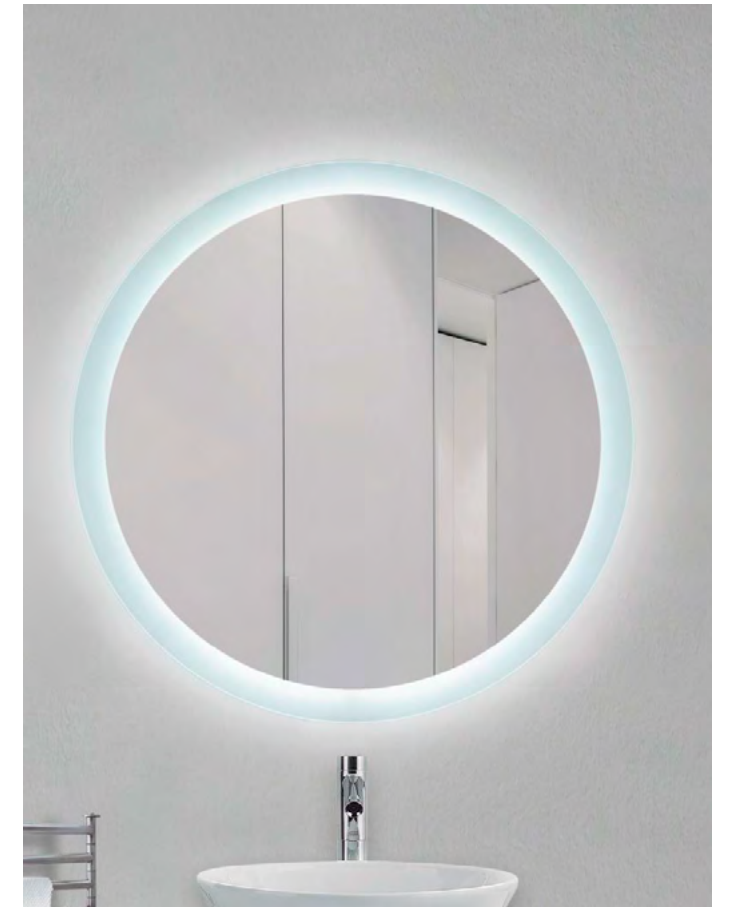

LIVIA collection

Ambient lighting



Organic mirrors with an edge screen-printed frame in different colors. Frameless, and smoothly polished edges to create a "free-floating effect" on the wall.

This screen-printed perimeter edge emulated visually the metal decorative frame, making it lighter in volume and weight, matching the rest of the accessories in the space.

Espejo de formas orgánicas que ofrece una iluminación ambiente, resaltando su borde serigrafiado en colores personalizables. Sin marco, con cantos suavemente pulidos para crear un "efecto volado" sobre la pared.

Este borde perimetral serigrafiado sustituye visualmente al marco decorativo metálico, aligerándolo en volumen y peso, permitiendo ir a juego con el resto de accesorios del espacio.



SPEHO
ILLUMINATED MIRRORS

LIVIA collection

Ambient lighting

SPEHO
ILLUMINATED MIRRORS

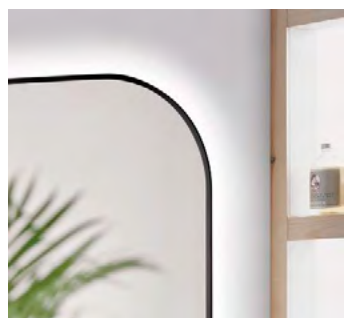
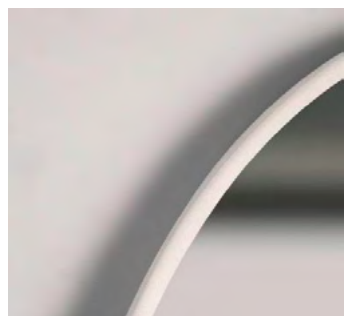

LIVIA collection

Ambient lighting

SPEHO
ILLUMINATED MIRRORS



Specifications

Especificaciones

Click install System
Sistema Click install

Lighting System led strip 120leds/m
Sistema de iluminación tira de led 120leds/m

Power 220-240V
Potencia 220-240V (Optional 110V)
(Opcional 110V)

Color temperature 3000K
Temperatura de color 3000K | 4000K | 5700K
| 4000K | 5700K

Screen printed edge 10mm
Borde serigrafiado 10mm

Minimum-maximum screen printed edge 10- 20 mm
Mínimo-máximo borde serigrafiado 10-20 mm

Glass 4 mm
Luna de 4 mm

Extra

Extras

- Defogger.
Antivaho.
- Lighted magnifying mirror.
Espejo aumento iluminado.
(For sizes / Para dimensiones > 800 mm)
- Adjustable intensity.
Intensidad regulable.
- Integrated magnifying mirror.
Espejo aumento integrado.
(For sizes / Para dimensiones > 800 mm)
- Touch sensor.
Sensor táctil.
- Adjustable color temperature
Temperatura de color regulable
- Laser or backlit logo.
Logo láser o retroiluminado.
- 2 Positions
2 Posiciones

Standard sizes (mm)

Dimensiones estándares (mm)

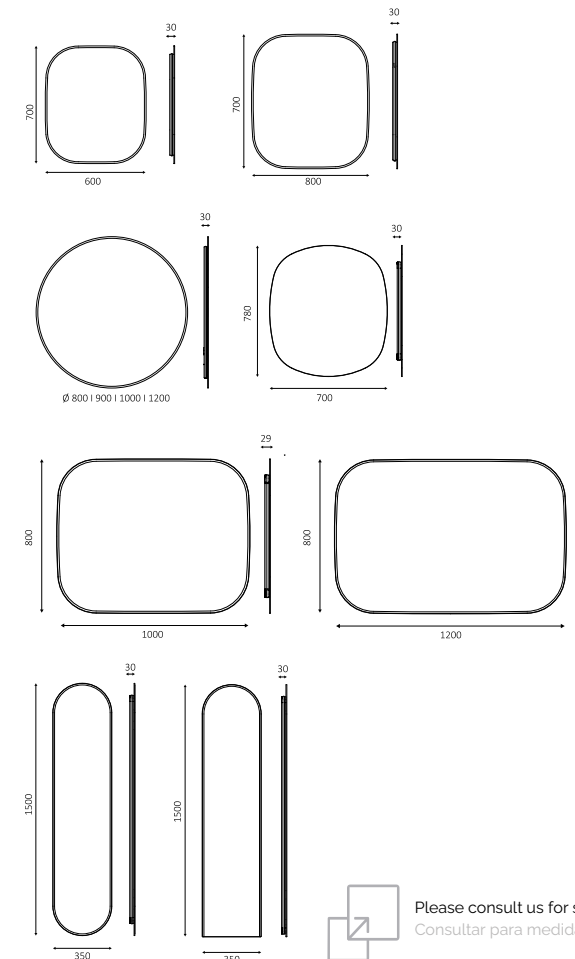

Please consult us for special sizes.
Consultar para medidas especiales.

Acabados

Finishing options



*Black: MOQ 30 units. Gold and White: MOQ 50 units.

*Negro: pedido mínimo 30 uds. Dorado y blanco: pedido mínimo 50 uds.



MARA collection

Ambient lighting



Frameless mirrors with smoothly polished edges to create a "free-floating effect" on the wall.

Espejos de iluminación indirecta sin marco, con cantos suavemente pulidos para crear un "efecto volado" sobre la pared.



SPEHO
ILLUMINATED MIRRORS

MARA collection

Ambient lighting

SPEHO
ILLUMINATED MIRRORS

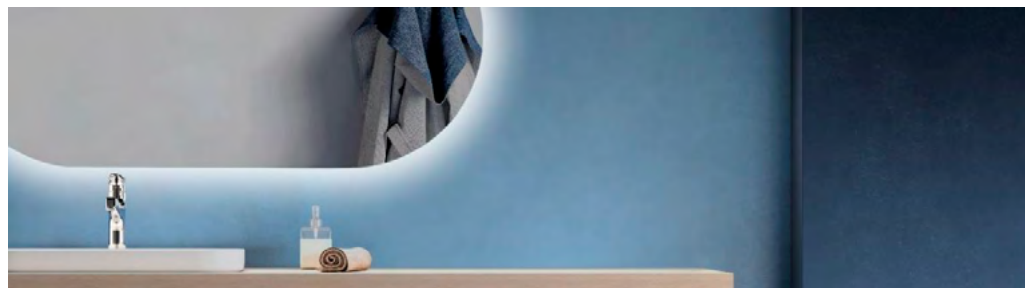
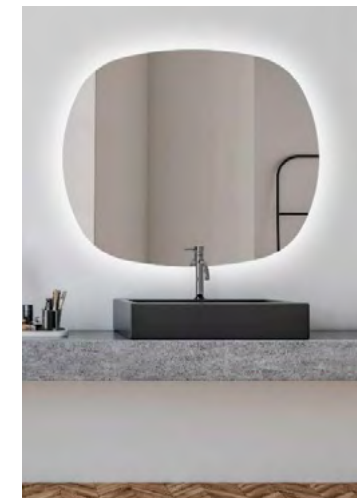
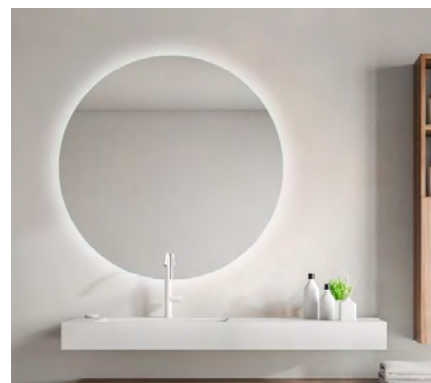

MARA collection

Ambient lighting

SPEHO
ILLUMINATED MIRRORS



Specifications

Especificaciones

Click install System
Sistema Qlick install

Lighting System led strip 120leds/m
Sistema de iluminación tira de led 120leds/m

Power 220-240V
Potencia 220-240V

(Optional 110V)
(Opcional 110V)

Color temperature 3000K
Temperatura de color 3000K

| 4000K | 5700K
| 4000K | 5700K

Glass 4 mm
Luna de 4 mm

Extra

Extras

- Defogger.
Antivaho.
- Lighted magnifying mirror.
Espejo aumento iluminado.
(For sizes / Para dimensiones > 800 mm)
- Adjustable color temperature
Temperatura de color regulable
- Integrated magnifying mirror.
Espejo aumento integrado.
(For sizes / Para dimensiones > 800 mm)
- Touch sensor.
Sensor táctil.
- Adjustable intensity.
Intensidad regulable.
- Laser or backlit logo.
Logo láser o retroiluminado.
- 2 Positions
2 Posiciones

Standard sizes (mm)

Dimensiones estándares (mm)

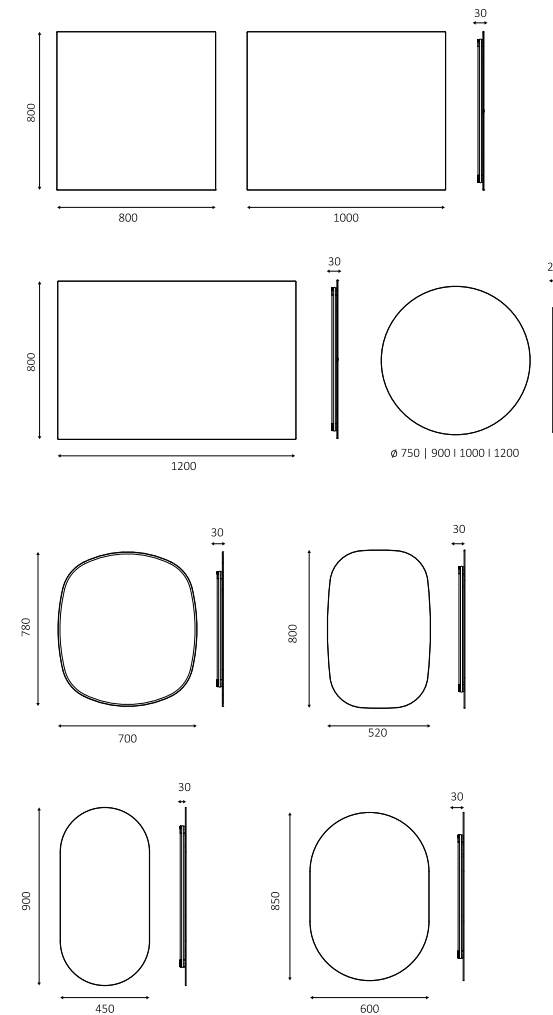

Please consult us for special sizes.
Consultar para medidas especiales.



SIENNA collection

Ambient lighting



Frameless mirrors with beveled edges. Smoothly polished edges to create a "free-floating effect" on the wall.

Ideal for bathroom, dressing room, bedroom, common areas... Spaces where you want to create a distinguished atmosphere with personality.

Espejos con el borde biselado, sin marco. Con cantos suavemente pulidos para crear un "efecto volado" sobre la pared.

Ideal para baño, vestidor, habitación, zonas comunes.. Espacios donde se quiera crear un ambiente distinguido y con personalidad.



SPEHO
ILLUMINATED MIRRORS

SIENNA collection

Ambient lighting

SPEHO
ILLUMINATED MIRRORS



Specifications

Especificaciones

Lighting System led strip 120leds/m
Sistema de iluminación tira de led 120leds/m

Power 220-240V
Potencia 220-240V

(Optional 110V)
(Opcional 110V)

Color temperature 3000K
Temperatura de color 3000K

| 4000K | 5700K
| 4000K | 5700K

Standard beveling 10mm
Biselado estándar de 10mm

(Optional min 10 -20mm)
(Opcional entre 10-20mm)

Glass 5 mm
Luna de 5 mm

Extra

Extras

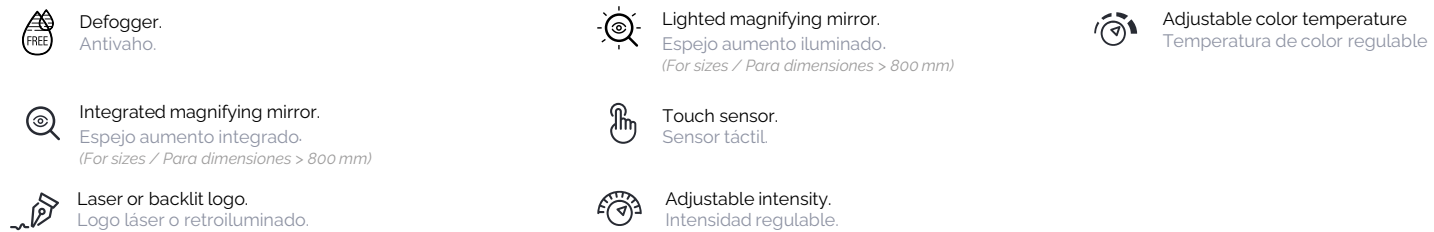

Standard sizes (mm)
Dimensiones estándares (mm)

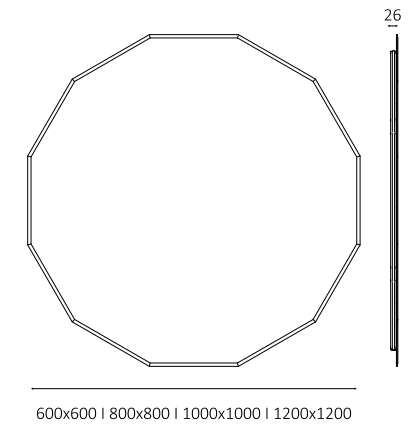

Inspiration.
Inspiración.

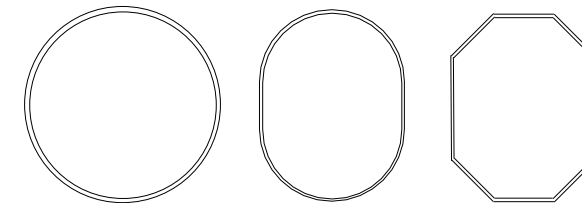

Please consult us for special sizes or shapes.
Consultar para medidas o formas especiales.



THIARA collection

Ambient lighting



Mirrors with "direct and indirect" light through a perimetral sandblasting, Frameless, and smoothly polished edges to create a "free-floating effect" on the wall.

Design that provides fluidity and distinction to the room, thanks to its shape and decorative lighting.

Espejos de luz "directa e indirecta" a través de un arenado perimetral. Sin marco, con cantos suavemente pulidos para crear un "efecto volado" sobre la pared.

Diseño que proporciona fluidez y distinción a la estancia, gracias a su forma e iluminación decorativa.



SPEHO

ILLUMINATED MIRRORS

THIARA collection

Ambient lighting

SPEHO
ILLUMINATED MIRRORS



Specifications

Especificaciones

Click install System
Sistema Qlick install

Lighting System led strip 120leds/m
Sistema de iluminación tira de led 120leds/m

Power 220-240V
Potencia 220-240V

(Optional 110V)
(Opcional 110V)

Color temperature 3000K
Temperatura de color 3000K

| 4000K | 5700K
| 4000K | 5700K

Distance of the sandblasting to the edge 10mm
Distancia del arenado al borde 10mm

(Min 10mm)
(Min 10mm)

Standard sandblasting width 15mm
Ancho estándar del arenado 15m

(Optional 12/18/28 mm)
(Opcional 12/18/28 mm)

Glass 4 mm
Luna de 4 mm

Extra

Extras

- Defogger.
Antivaho.
- Lighted magnifying mirror.
Espejo aumento iluminado.
(For sizes / Para dimensiones > 800 mm)
- Adjustable intensity.
Intensidad regulable.
- Integrated magnifying mirror.
Espejo aumento integrado.
(For sizes / Para dimensiones > 800 mm)
- Touch sensor.
Sensor táctil.
- Adjustable color temperature.
Temperatura de color regulable.
- Laser or backlit logo.
Logo láser o retroiluminado.
- 2 Positions
2 Posiciones

Standard sizes (mm)
Dimensiones estándares (mm)

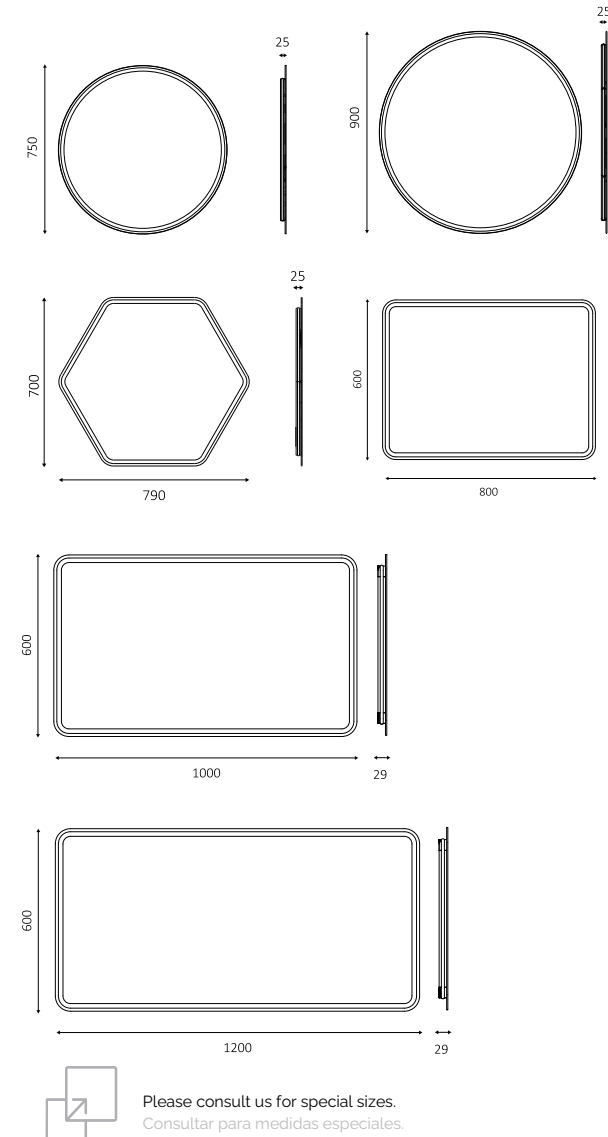

Please consult us for special sizes.
Consultar para medidas especiales.

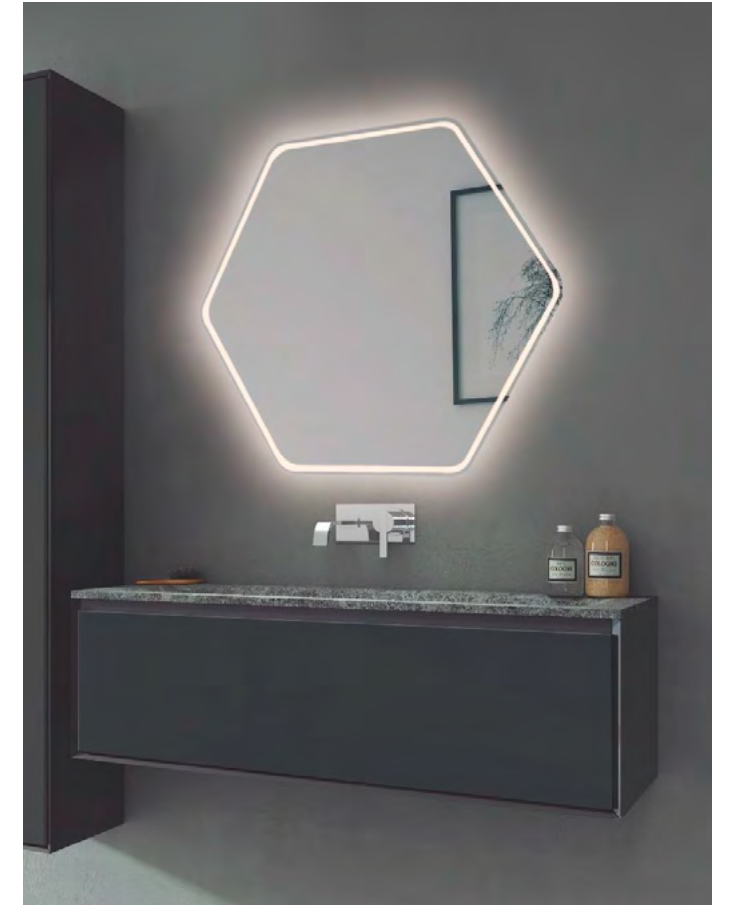

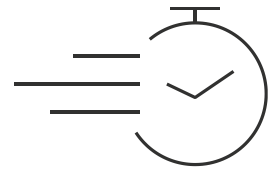

+ EASY

- Reduction in installation time.
- Greater tolerance margin in installation.

+ FÁCIL

- Reducción en el tiempo de instalación.
- Mayor margen de tolerancia en la instalación.

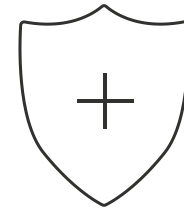

+SAFE

- "Click" sound to indicate correct hanging.
- Mirror block system which prevents it from becoming unhooked or lifting up.

+SEGURO

- Ajuste asegurado al oír el "click".
- Sistema de bloqueo del espejo que evita que pueda descolgarse o levantarse.

"Click install" System

This system allows you to fasten the mirror quickly and safely. It reduces assembly times and prevents mistakes in the installation thanks to its tolerance margin. It blocks the mirror with a click, preventing it from becoming unhooked or lifting up for greater user safety.

Sistema Qlick install

Este sistema, permite fijar el espejo de forma rápida y segura. Reduce los tiempos de montaje y evita errores en la instalación gracias a su ajuste de tolerancia. Bloquea el espejo con un "Click" evitando que pueda descolgarse o levantarse para mayor seguridad del usuario.

"Click System"



Easy and quick assembly
Montaje fácil y rápido

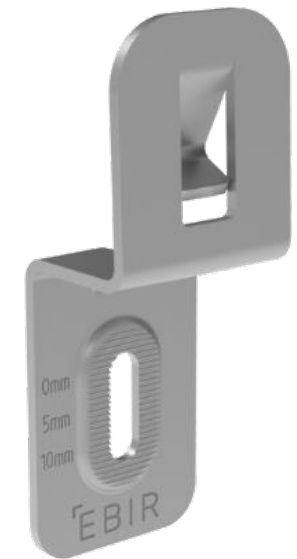

Due to design limitations, these collections will not be able to carry the "Click install" system: Aina, Edna and Lisbeth.

Por limitaciones del diseño, estas colecciones no podrán llevar el sistema "Qlick install": Aina, Edna y Lisbeth,

Thank you
Gracias

SPEHO

ILLUMINATED MIRRORS